



Coordinating Bamboo Accessories



AVAILABLE IN TRADITIONAL AND STRAND BAMBOO

Complete your design with our extensive line of accessories that coordinate with all Teragren products.

- | | |
|--|---|
|  PORTFOLIO COLORS |  STUDIO |
|  PORTFOLIO NATURALS |  CRAFTSMAN II |
|  SYNERGY® MPL |  SIGNATURE COLORS |
| |  SIGNATURE NATURALS |

TRIM

Base Molding

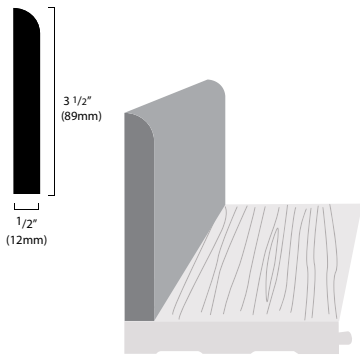

 72" x 3.5" x 0.5"

Base Molding

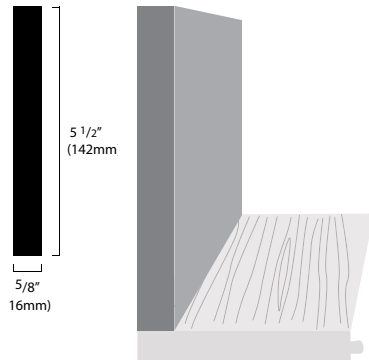

 72" x 5.59" x 0.63"



    74" x 3.5" x 0.5"

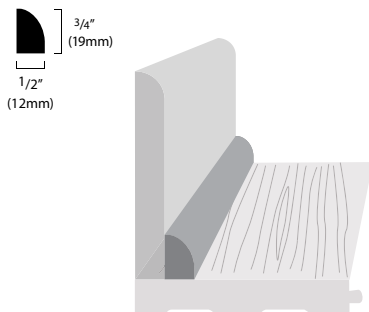

Teragren Flooring, Stair Treads + Risers
vertical grain Natural

Base Shoe



   72" x 0.75" x 0.5"

    74" x 0.75" x 0.5"

Floor Vents

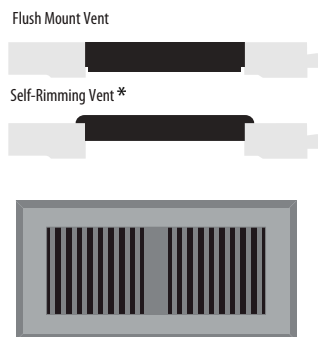

4x12" or 4" x 10"

**Portfolio Colors self-rimming only*

Architectural Molding

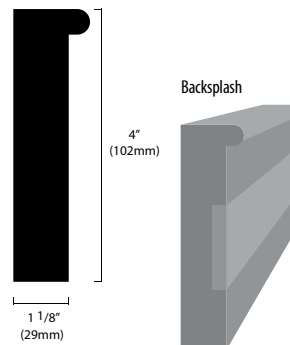

96" x 3.98" x 0.79"

Architectural Casing

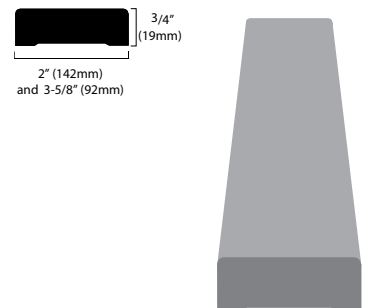

LENGTH: 96" (2440mm)

TRANSITIONS

Baby Threshold

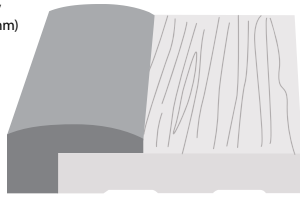
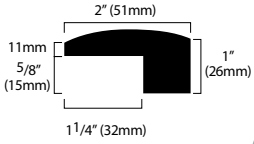

- 72" x 2" x .75"
- 74" x 2" x 1"

T-mold

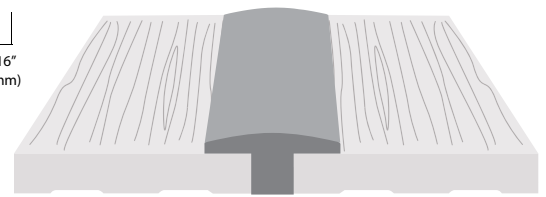
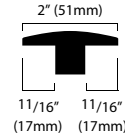

- 72" x 2" x 0.83"
- 74" x 2" x .94"

Clamshell Reducer

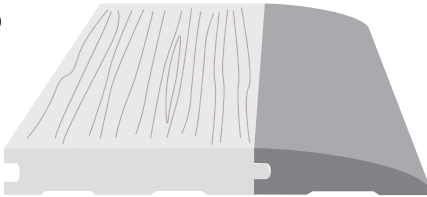

- 72" x 2.36" x .47"
- 74" x 2.37" x .59"

Floating Floor Reducer

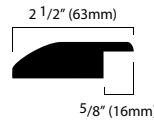

- 72" x 2.48" x .77"
- 74" x 2.5" x .75"
- 74" x 2.5" x .81"

STAIR PARTS

Stair Nosing

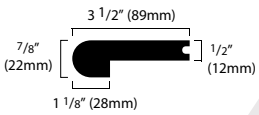

- 72" x 3.5" x 1.14"
- 48" x 11.5" x 1" or 74" x 3.54" x 1"

Stair Nosing for Floating Floors

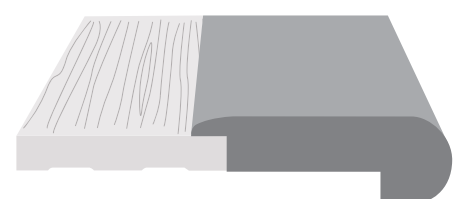
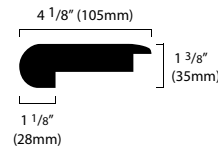

- 72" x 4.17" x 1.38"
- 74" x 4.13" x 1.38"

Stair Tread

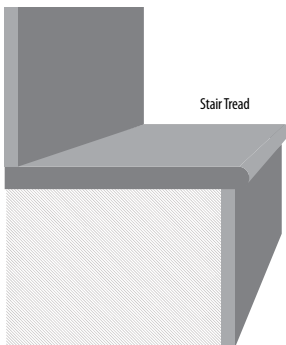
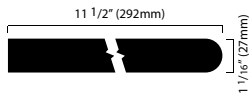

- 48" x 11.5" x 1"
- 48" x 11.5" x 1" or 96" x 11.5" x 1"

Stair Riser

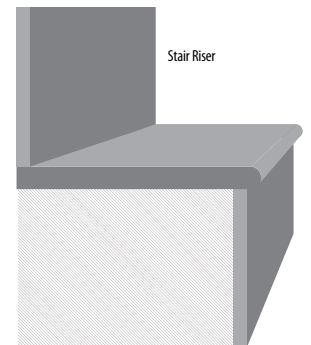
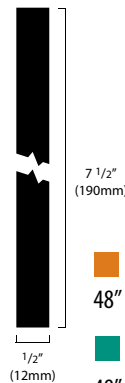

- 48" x 7.48" x 0.59"
- 48" x 7.48" x 0.59" or 96" x 7.5" x 0.63"



FINE BAMBOO FLOORING, PANELS & WORKTOPS

www.teragren.com | toll-free: 800.929.6333

Teragren, the Teragren logo and Optimum 5.5 are registered trademarks of Teragren LLC.
© 2012 Teragren LLC. All rights reserved.